

Sensors & Applications  
**Battery production**



More Precision



Coating

Drying

Calendering

Cutting

Assembly

Filling

Formation

Energy storage devices such as lithium-ion batteries play a crucial role for electromobility and energy transition. The growing demand for these means is met by Gigafactories which are equipped with efficient and highly automated production technologies.

In order to optimize the battery production, sensors are required which monitor the production line to the highest accuracy and dynamic. Micro-Epsilon offers reliable solutions from high precision distance sensors to infrared temperature measurement technology and 2D/3D profile sensors for multiple measurement tasks involved in battery production. These sensors are used in diverse fields from electrode manufacturing to assembly and forming processes.



### **confocalDT**

Confocal chromatic sensors for high precision distance measurement

---

One-sided thickness measurement of transparent materials

---

Synchronous 2-channel measurement with only one controller

---

Ideal for dynamic measurement tasks due to high measuring rate



### **interferoMETER**

White light interferometer for high precision distance and thickness measurements

---

Absolute distance measurement with nanometer accuracy

---

Distance-independent thickness measurements

---

Best-in-Class: Resolution < 30 picometers

---

Ideal for industrial measurement tasks



### **capaNCDT**

Capacitive sensor system for non-contact displacement and distance measurements

---

Measuring ranges from 0.05 to 10 mm

---

Nanometer resolution

---

High frequency response for dynamic measurements

---

Ideal for long-term stable measurements



### **scanCONTROL**

High-end laser scanner for high precision 2D/3D measurements

---

Inline measurement of gaps, profiles, steps, angles

---

Models with red and patented blue laser line

---

Measurement on numerous surfaces, also reflecting and matt

# Thickness measurements

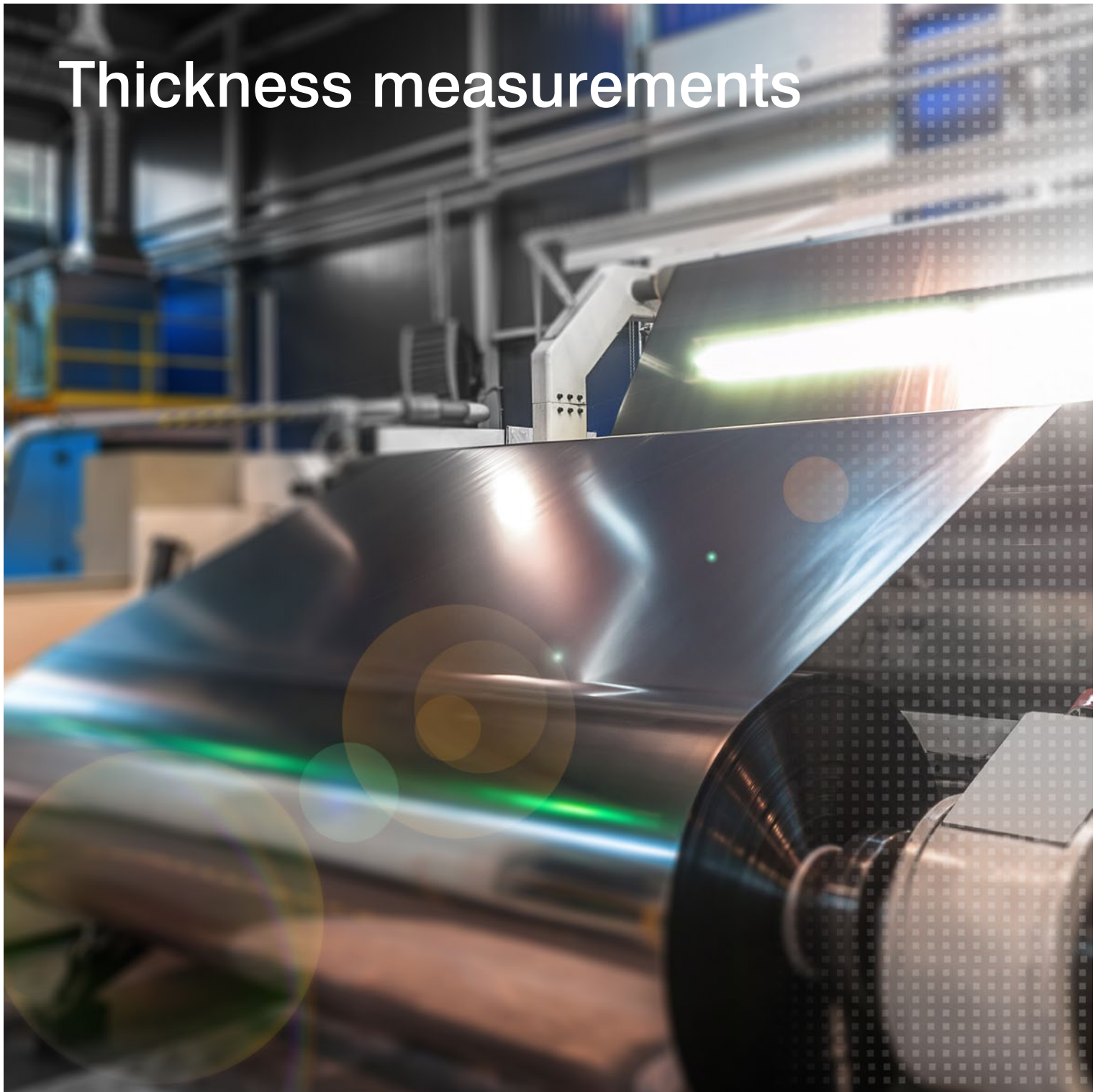

## One-sided thickness measurement

Thickness measurement from one side is possible using confocal chromatic sensors, white light interferometers and a combiSENSOR. One-sided thickness measurements are normally used in monitoring and controlling of coating processes.

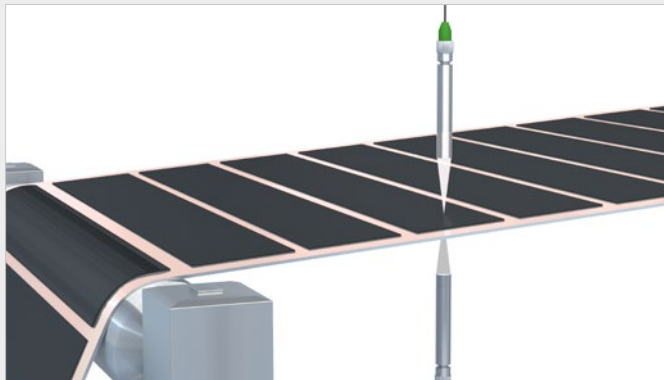
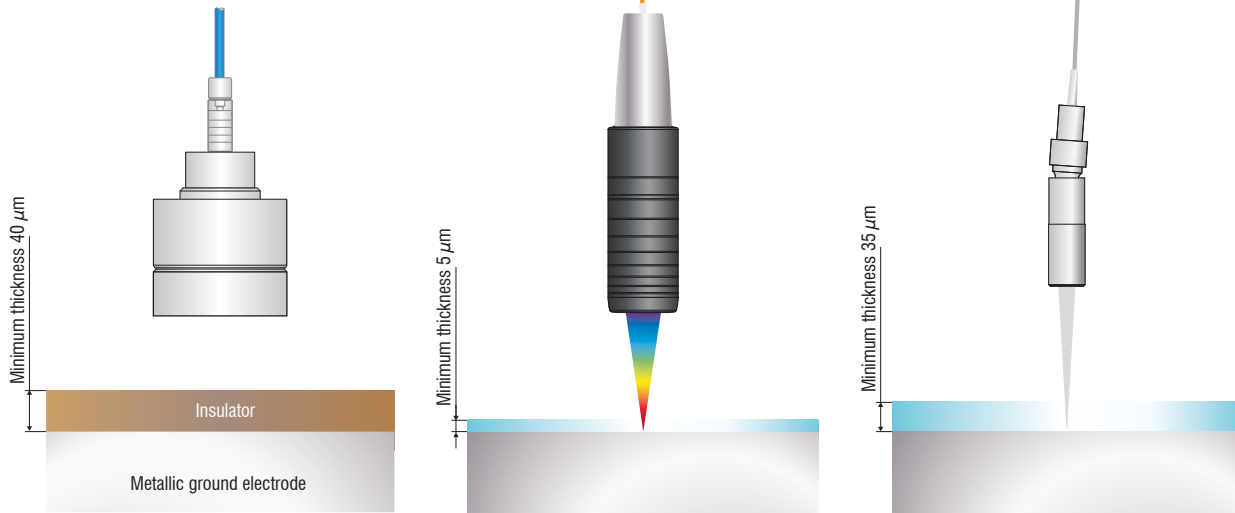

## Thickness measurement of electrode coatings

White light interferometers arranged on two sides detect the thickness of coated electrodes according to the differential thickness method. They respectively determine the distance from the film while a constant distance between the sensors is maintained. The white light interferometers enable a measurement resolution in the nanometer range. The thickness values are used to control the application of the coating and for quality assurance purposes.

Sensor: *interferoMETER IMS5400*

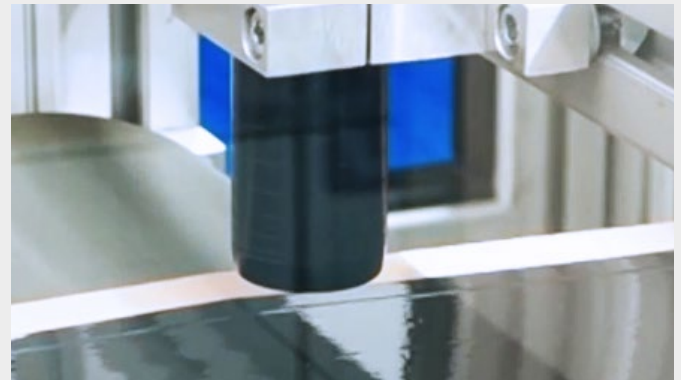

## Measuring the thickness of wet layers

Confocal chromatic sensors from Micro-Epsilon monitor the coating thickness of wet materials. These sensors provide both extremely high resolution and high measuring rates. Installing several sensors next to each other enables concurrent determination of the homogeneity of the coating over the complete strip width.

Sensor: *confocalDT*

# Thickness measurements

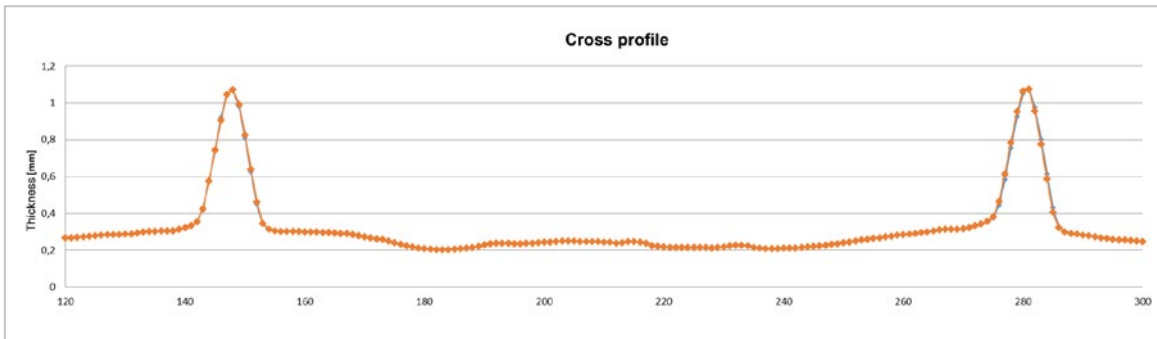
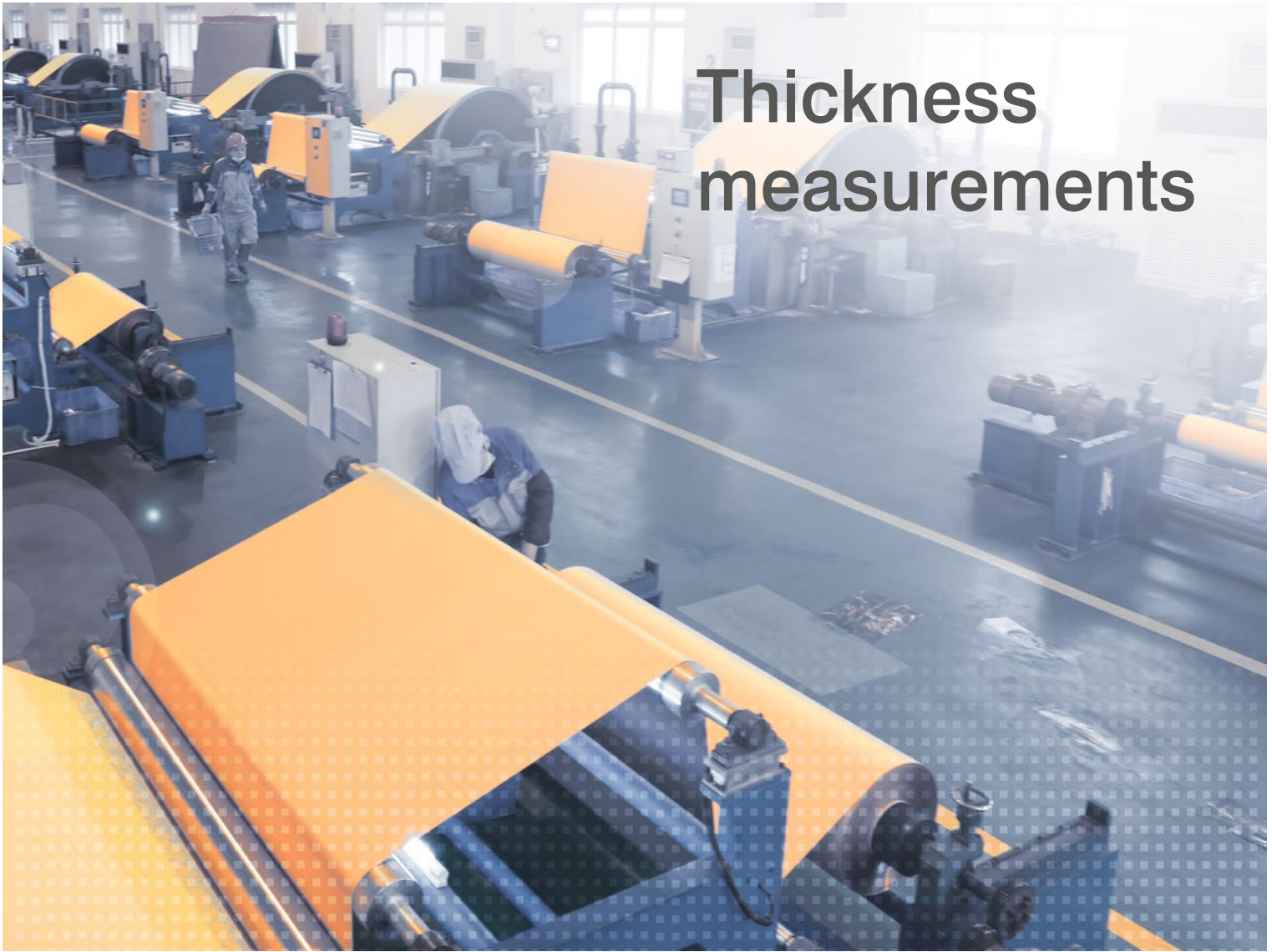

**Thickness profile evaluation**  
If the sensor is traversed via the strip material, thickness profiles can be evaluated.

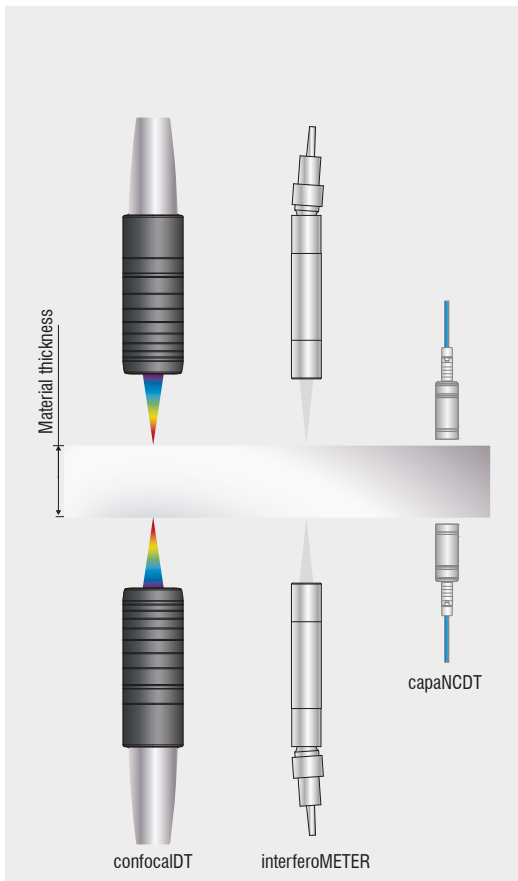

### Two-sided thickness measurement

With double-sided thickness measurements, two sensors are arranged opposite each other and measure the distance to the film. Depending on the type of sensor used, this arrangement achieves an extremely high resolution. Depending on the measurement object and the coating type (uncoated/coated), you can choose the sensor which fits best.



### Thickness measurement using capacitive sensors

Two-sided thickness measurement of electrically conductive materials can be performed by installing the capacitive sensors opposite each other. Strip thicknesses in the  $\mu\text{m}$  range can be measured using this method. Each of the two capacitive displacement sensors provides a linear distance signal which is calculated by the controller as a thickness measurement value. The measuring spot of the sensors is larger than that of the optical methods, which averages out any structures and anomalies on the surface.

Sensor: *capaNCDT 6200*

### Turnkey measuring systems

As well as sensors, Micro-Epsilon provides turnkey measuring systems for integration in production lines, which enable high mechanical stability and measurement accuracy. Robust mechanics and innovative software evaluation enable the optimization of temperature stability and linearity. The measurement can be performed in fixed tracks or while traversing over the film web. Depending on the film or strip material and metrological specifications, the measuring systems are equipped with the sensors which fit best.

Turnkey measuring systems - here a double-sided measuring C-frame with traversing axis, equipped with confocal chromatic sensors - allow reliable integration into production lines



# 2D/3D Profile measurement

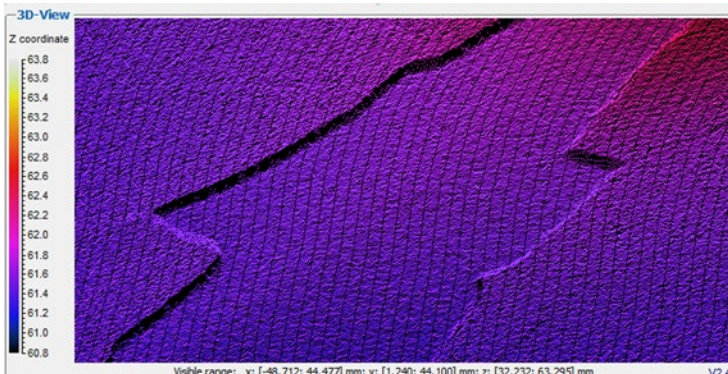
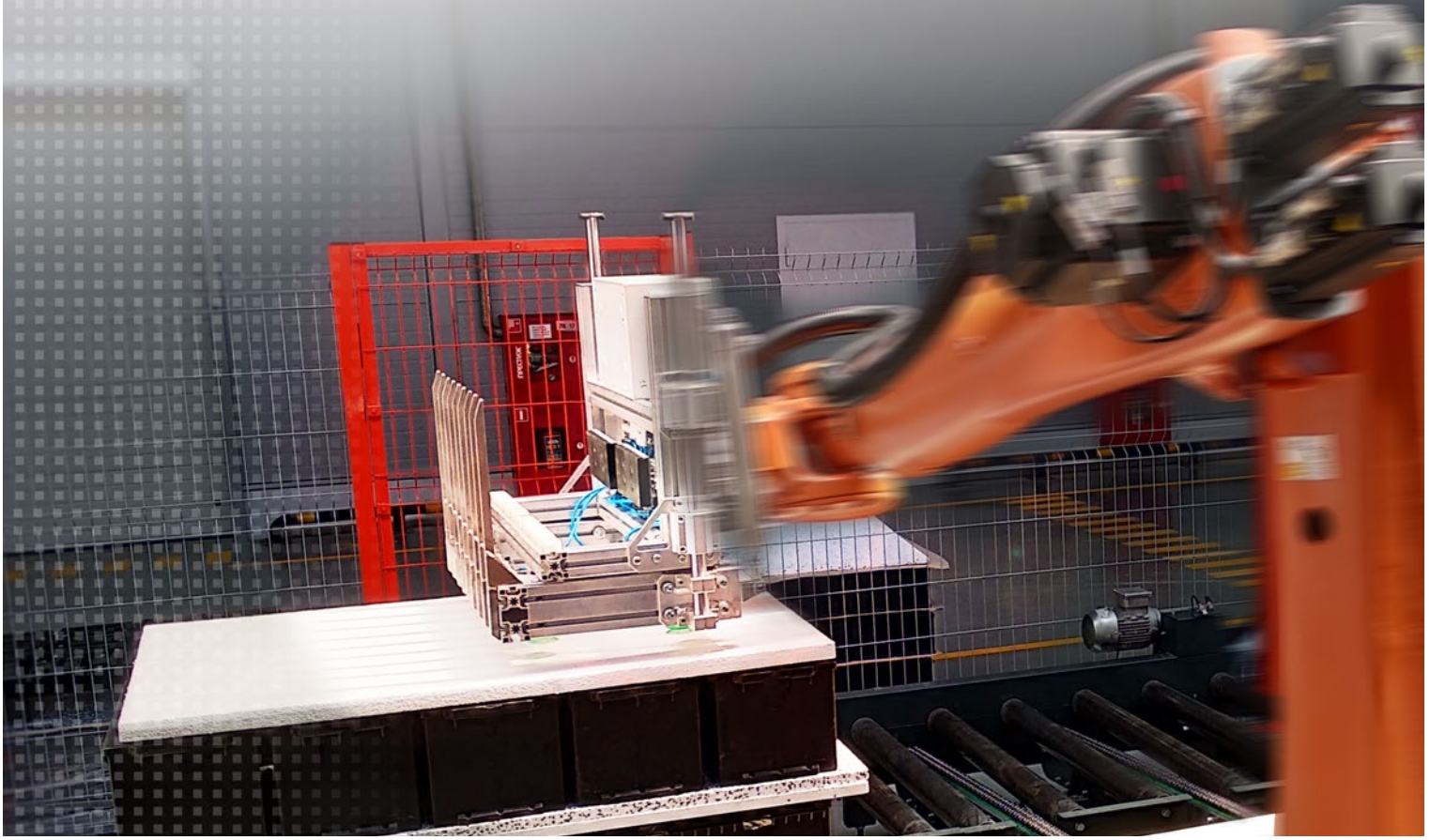

## 3D Surface inspection

Due to high resolution and stable signals on different measurement objects, the scanCONTROL sensors are used for 3D inspection of coated films. Defects with the smallest geometries – e.g. spalling and inclusions – are reliably recognized and output by the scanners.

Sensor: scanCONTROL





### Inspection of adhesive beading and applied sealants

scanCONTROL laser scanners inspect the presence and dimension of adhesive beading. They are mounted on the dispenser in order to control the quantity applied and the distance from the dispenser. Their high resolution enables them to reliably detect even the finest of beads. This is how breaks and flaws can be reliably detected regardless of the type of application or the color applied.

*Sensor: scanCONTROL*

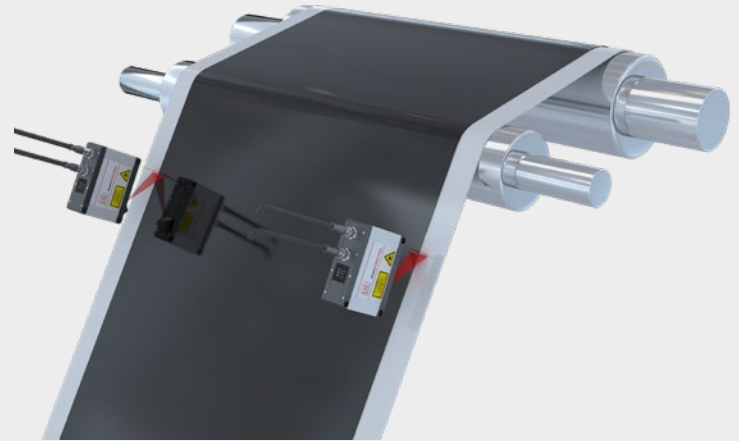

### Coating application on edges

Electrodes must be coated with extreme precision. Therefore, laser scanners from Micro-Epsilon inspect the coating profile on the edge. This is how anomalies and undulations are detected.

*Sensor: scanCONTROL*

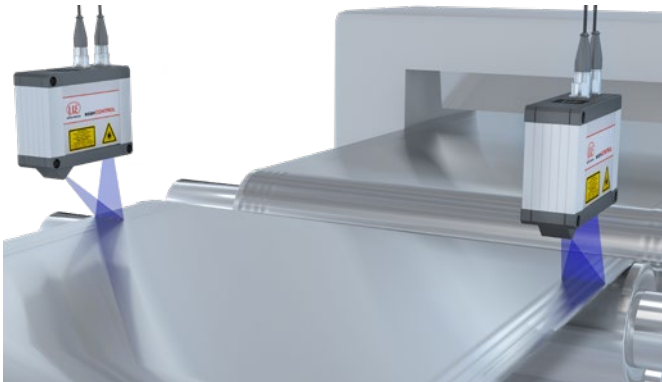

### Detection of curved edges after cutting

Films may have curvatures and deformations after longitudinal cutting. In order to detect these deviations reliably, laser profile sensors from Micro-Epsilon are used. Due to their extremely high resolution and insensitivity to reflecting surfaces, these sensors provide stable measurement results.

*Sensor: scanCONTROL*

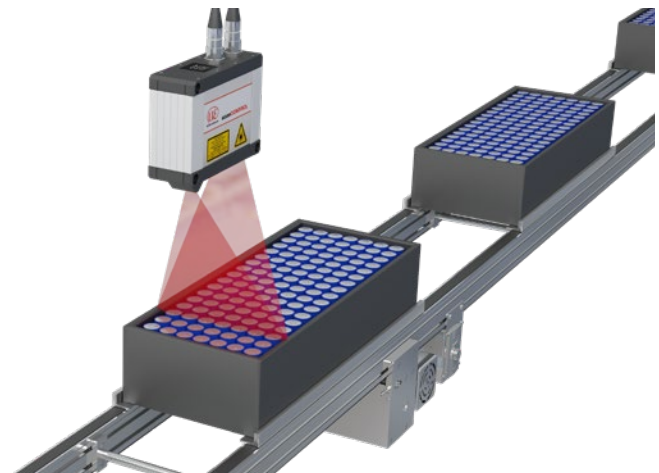

### Position control of battery cells

After the battery cells have been assembled, laser scanners from Micro-Epsilon inspect their completeness and position. Therefore, a 3D image is generated which is then compared with the CAD data.

*Sensor: scanCONTROL*

# Non-contact measurement of temperature and edge



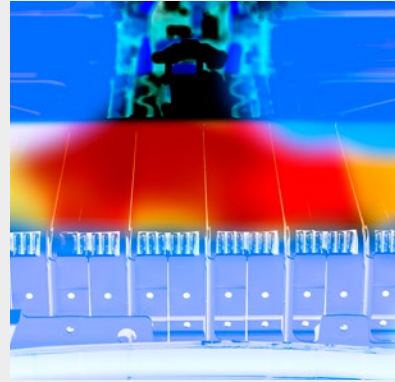

### Temperature monitoring during initial charge

Thermal imaging cameras monitor the first charging process of batteries. They provide an insight into the temperature distribution and any possible short circuits. The automatic hot-spot detection feature automatically recognizes and outputs deviations from the target temperature.

Sensor: *thermoIMAGER*



### Web edge control of electrode film

During the production of battery cells, electrode and separator films must be guided reliably. Optical optoCONTROL micrometers detect the required edge position for web edge control with high accuracy. Operating several micrometers enables the concurrent detection of the web width.

Sensor: *optoCONTROL 2520*

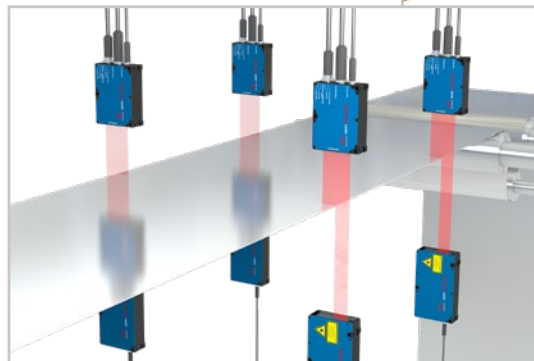
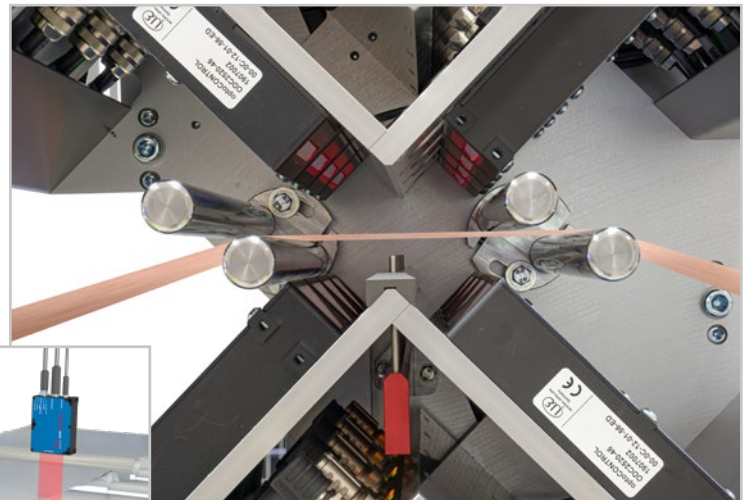

## Sensors and Systems from Micro-Epsilon



Sensors and systems for displacement, distance and position



Sensors and measurement devices for non-contact temperature measurement



Measuring and inspection systems for metal strips, plastics and rubber

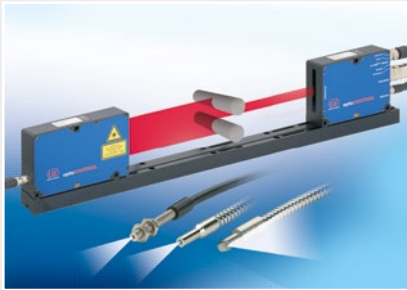

Optical micrometers and fiber optics, measuring and test amplifiers



Color recognition sensors, LED analyzers and inline color spectrometers

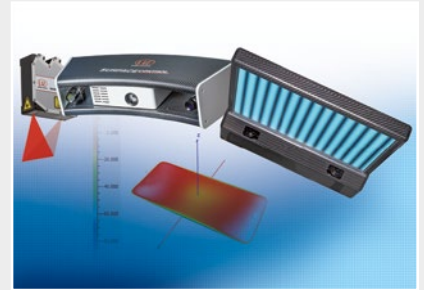

3D measurement technology for dimensional testing and surface inspection

**SCIENCE  
GATE**  
Your Automation Partner



**SCIGATE AUTOMATION (S) PTE LTD**

Bukit Batok Street 22 #01-01 Singapore 659592

Tel: (65) 6561 0488

Fax: (65) 6561 0588

Email: [sales@scigate.com.sg](mailto:sales@scigate.com.sg)

Web: <https://scigate.com.sg/>

Business Hours: Monday - Friday 8:30AM - 6:15PM

## More Precision

Whether it is for quality assurance, predictive maintenance, process and machine monitoring, automation or R&D – sensors from Micro-Epsilon make a vital contribution to the improvement of products and processes. High precision sensors and measuring systems solve measurement tasks in all core industries – from machine building to automated production lines and integrated OEM solutions.



**MICRO-EPSILON**

[www.micro-epsilon.com](http://www.micro-epsilon.com)